

# DATA SHEET

## **PN4416; PN4416A** N-channel field-effect transistor

Product specification  
File under Discrete Semiconductors, SC07

December 1997

# N-channel field-effect transistor

# PN4416; PN4416A

### FEATURES

- Low noise
- Interchangeability of drain and source connections
- High gain.

### DESCRIPTION

N-channel symmetrical silicon junction FETs in a SOT54 envelope. These devices are intended for use in VHF/UHF amplifiers, oscillators and mixers.

### PINNING - SOT54 (TO-92).

PIN	DESCRIPTION
1	gate
2	source
3	drain

### QUICK REFERENCE DATA

SYMBOL	PARAMETER	CONDITIONS	MIN.	MAX.	UNIT
$V_{DS}$	drain-source voltage				
	PN4416		–	30	V
	PN4416A		–	35	V
$I_{DSS}$	drain current	$V_{DS} = 15\text{ V}; V_{GS} = 0$	5	15	mA
$P_{tot}$	total power dissipation	up to $T_{amb} = 25\text{ °C}$	–	400	mW
$V_{GS(off)}$	gate-source cut-off voltage	$V_{DS} = 15\text{ V}; I_D = 1\text{ nA}$			
	PN4416		–	–6	V
	PN4416A		–2.5	–6	V
$ Y_{fs} $	common-source transfer admittance	$V_{DS} = 15\text{ V}; V_{GS} = 0; f = 1\text{ kHz}$	4.5	7.5	mS

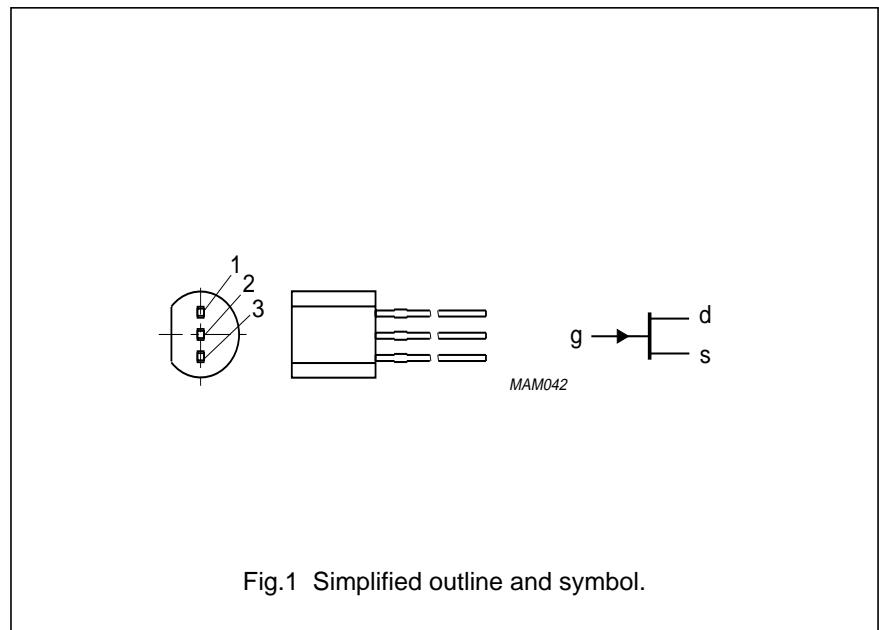

## N-channel field-effect transistor

## PN4416; PN4416A

**LIMITING VALUES**

In accordance with the Absolute Maximum Rating System (IEC 134).

SYMBOL	PARAMETER	CONDITIONS	MIN.	MAX.	UNIT
V <sub>DS</sub>	drain-source voltage				
	PN4416		–	30	V
	PN4416A		–	35	V
V <sub>GSO</sub>	gate-source voltage				
	PN4416		–	–30	V
	PN4416A		–	–35	V
V <sub>GDO</sub>	gate-drain voltage				
	PN4416		–	–30	V
	PN4416A		–	–35	V
I <sub>G</sub>	DC forward gate current		–	10	mA
P <sub>tot</sub>	total power dissipation	up to T <sub>amb</sub> = 25 °C (note 1)	–	400	mW
T <sub>stg</sub>	storage temperature		–65	+150	°C
T <sub>j</sub>	junction temperature		–	150	°C

**THERMAL RESISTANCE**

SYMBOL	PARAMETER	THERMAL RESISTANCE
R <sub>th j-a</sub>	from junction to ambient (note 1)	350 K/W

**Note**

1. Mounted on a printed-circuit board, maximum lead length 4 mm, mounting pad for drain leads 10 mm<sup>2</sup>.

**STATIC CHARACTERISTICS**T<sub>j</sub> = 25 °C unless otherwise specified.

SYMBOL	PARAMETER	CONDITIONS	MIN.	MAX.	UNIT
V <sub>(BR)GSS</sub>	gate-source breakdown voltage	V <sub>DS</sub> = 0; I <sub>G</sub> = –1 μA			
	PN4416		–30	–	V
	PN4416A		–35	–	V
I <sub>GSS</sub>	reverse gate leakage current	V <sub>DS</sub> = 0; V <sub>GS</sub> = –15 V	–	–1	nA
I <sub>DSS</sub>	drain current	V <sub>DS</sub> = 15 V; V <sub>GS</sub> = 0	5	15	mA
V <sub>GSS</sub>	gate-source forward voltage	V <sub>DS</sub> = 0; I <sub>G</sub> = 1 mA	–	1	V
V <sub>GS(off)</sub>	gate-source cut-off voltage	V <sub>DS</sub> = 15 V; I <sub>D</sub> = 1 nA			
	PN4416		–	–6	V
	PN4416A		–2.5	–6	V
Y <sub>fs</sub>	common source transfer admittance	V <sub>DS</sub> = 15 V; V <sub>GS</sub> = 0	4.5	7.5	mS
Y <sub>os</sub>	common source output admittance	V <sub>DS</sub> = 15 V; V <sub>GS</sub> = 0			
	PN4416		–	50	μS
	PN4416A		–	50	μS

N-channel field-effect transistor

PN4416; PN4416A

**DYNAMIC CHARACTERISTICS**

$T_j = 25\text{ }^\circ\text{C}$ ;  $V_{DS} = 15\text{ V}$ ;  $V_{GS} = 0$ .

SYMBOL	PARAMETER	CONDITIONS	MIN.	TYP.	MAX.	UNIT
$C_{is}$	input capacitance	$f = 1\text{ MHz}$	–	–	4	pF
$C_{os}$	output capacitance	$f = 1\text{ MHz}$	–	–	2	pF
$C_{rs}$	feedback capacitance	$f = 1\text{ MHz}$	–	–	0.8	pF
$g_{is}$	common source input conductance	$f = 100\text{ MHz}$	–	–	100	$\mu\text{S}$
		$f = 400\text{ MHz}$	–	–	1	mS
$g_{fs}$	common source transfer conductance	$f = 100\text{ MHz}$	–	5.2	–	mS
		$f = 400\text{ MHz}$	4	5	–	mS
$g_{rs}$	common source feedback conductance	$f = 100\text{ MHz}$	–	–8	–	$\mu\text{S}$
		$f = 400\text{ MHz}$	–	–100	–	$\mu\text{S}$
$g_{os}$	common source output conductance	$f = 100\text{ MHz}$	–	–	75	$\mu\text{S}$
		$f = 400\text{ MHz}$	–	–	100	$\mu\text{S}$
$V_n$	equivalent input noise voltage	$f = 100\text{ Hz}$	–	5	–	nV/ $\sqrt{\text{Hz}}$

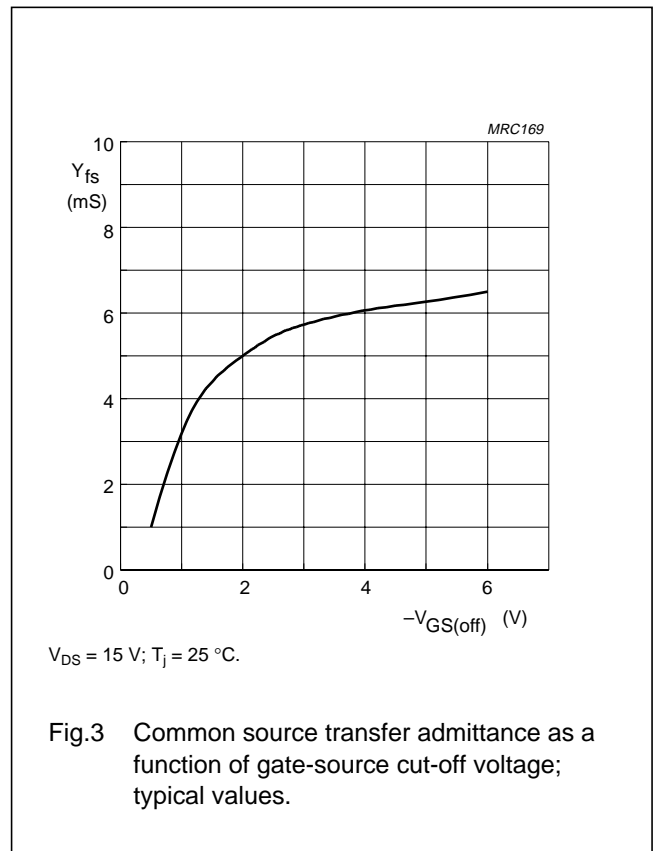
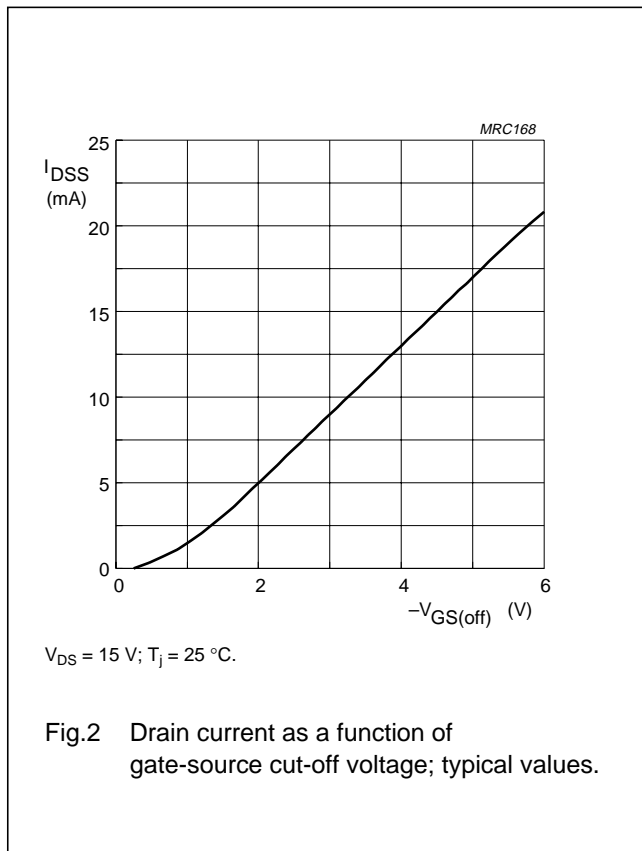

N-channel field-effect transistor

PN4416; PN4416A

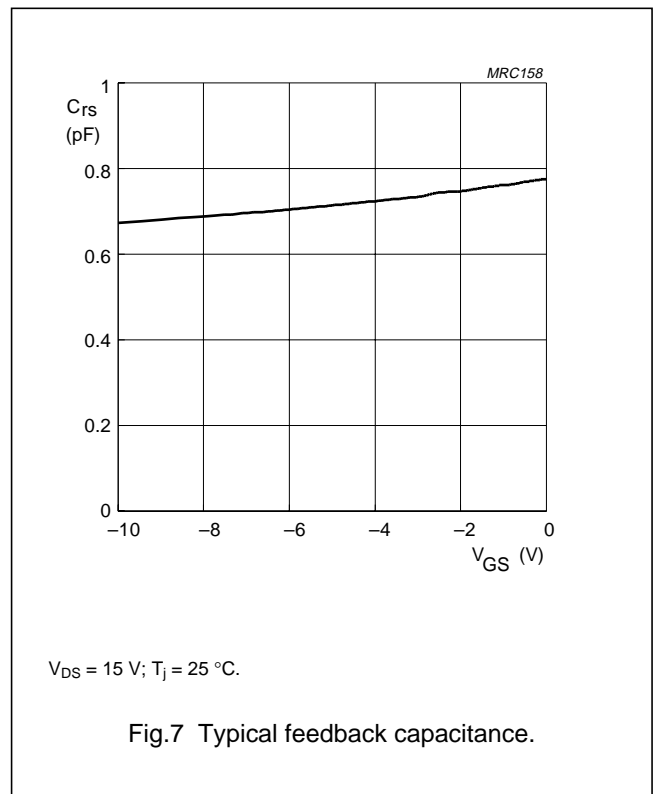
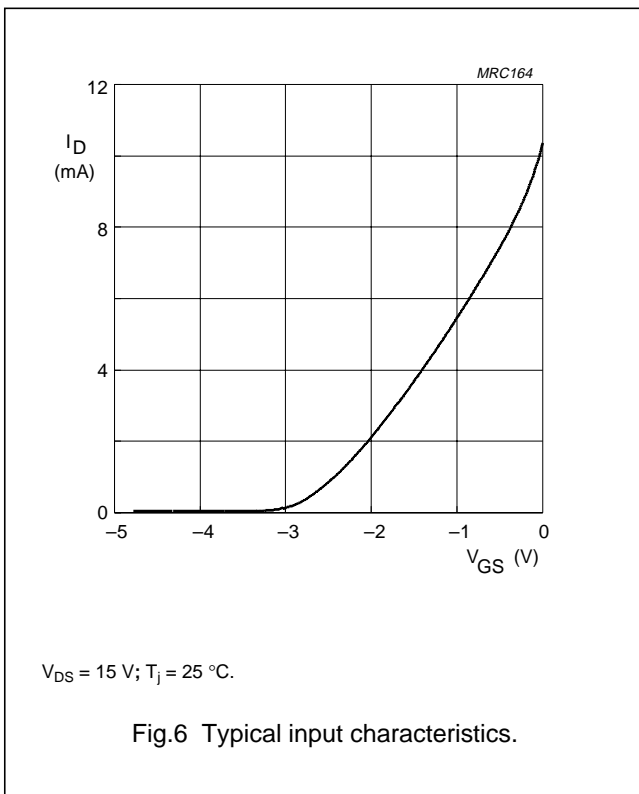
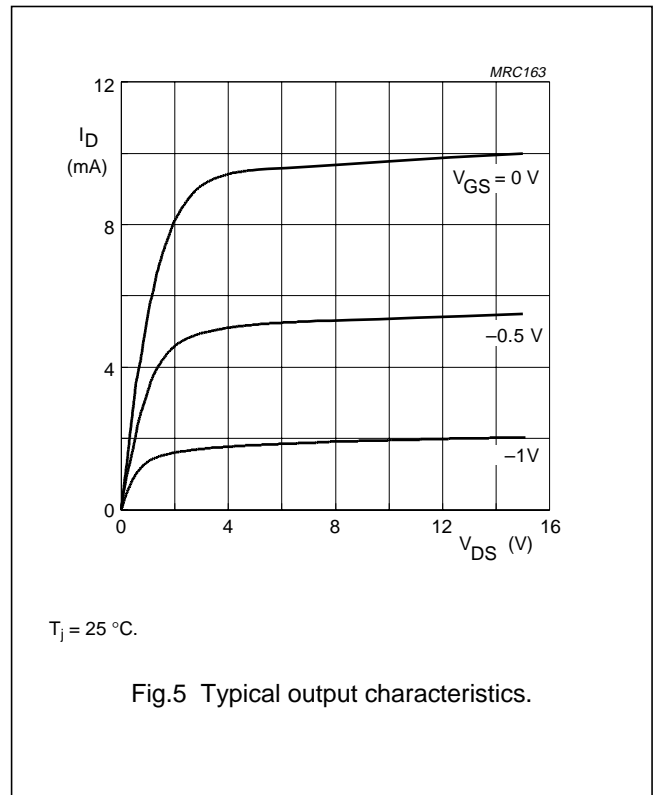
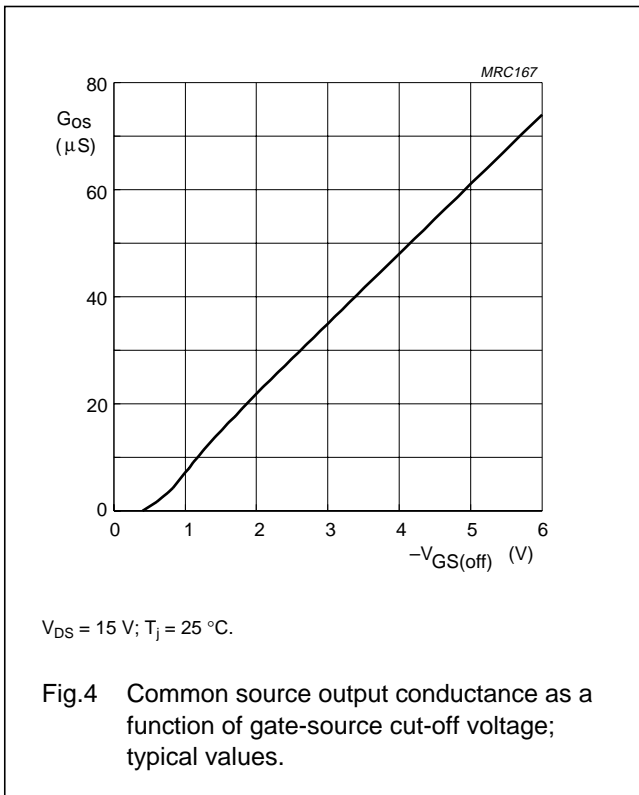

N-channel field-effect transistor

PN4416; PN4416A

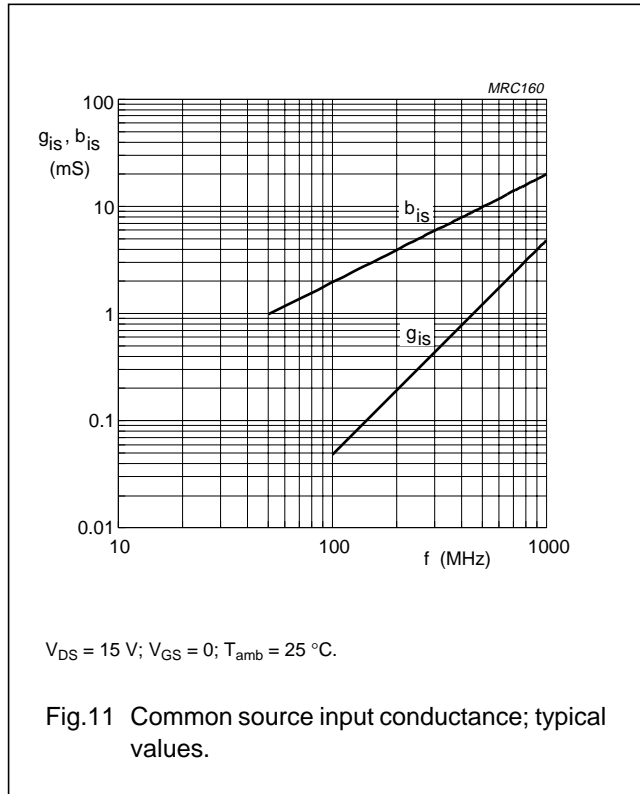
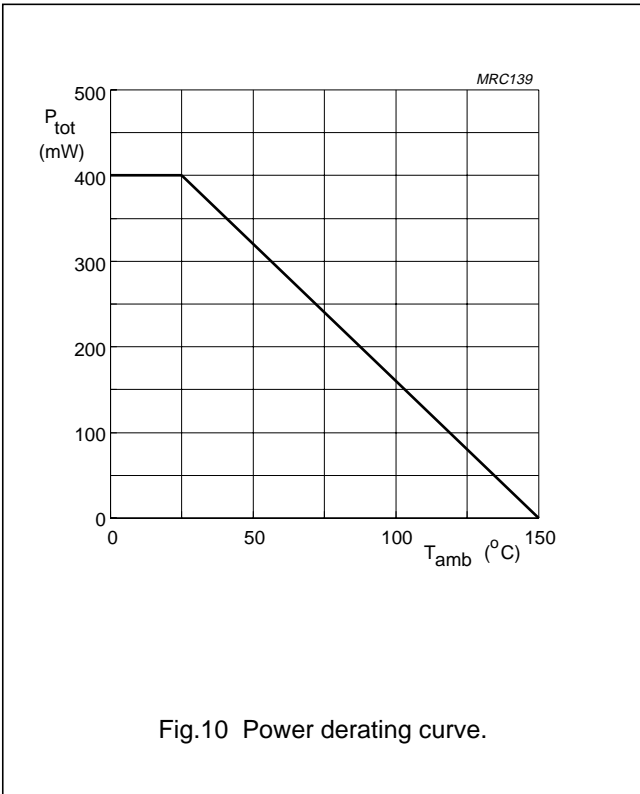
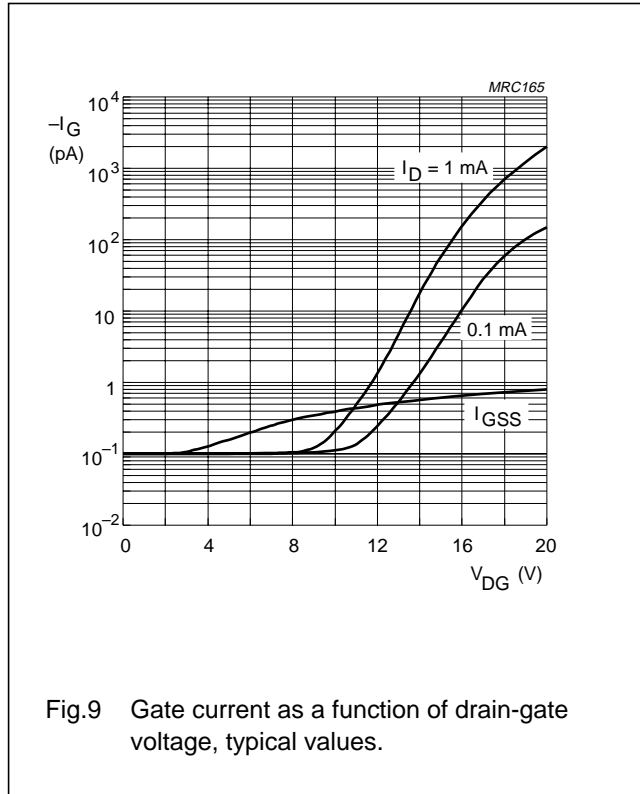
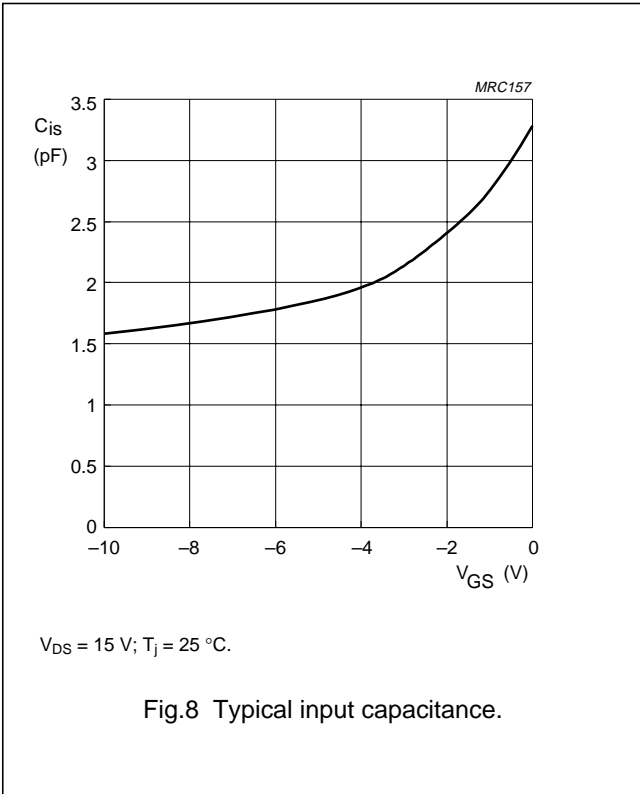

N-channel field-effect transistor

PN4416; PN4416A

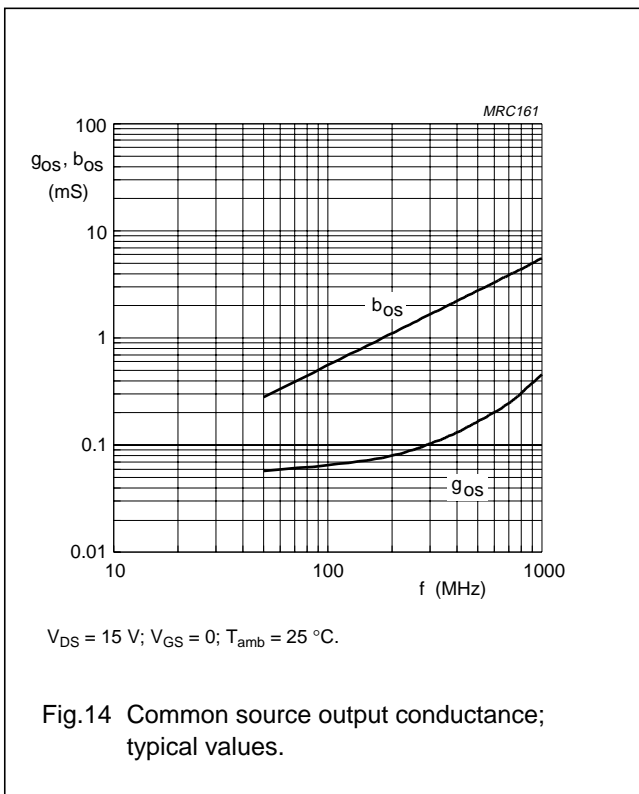
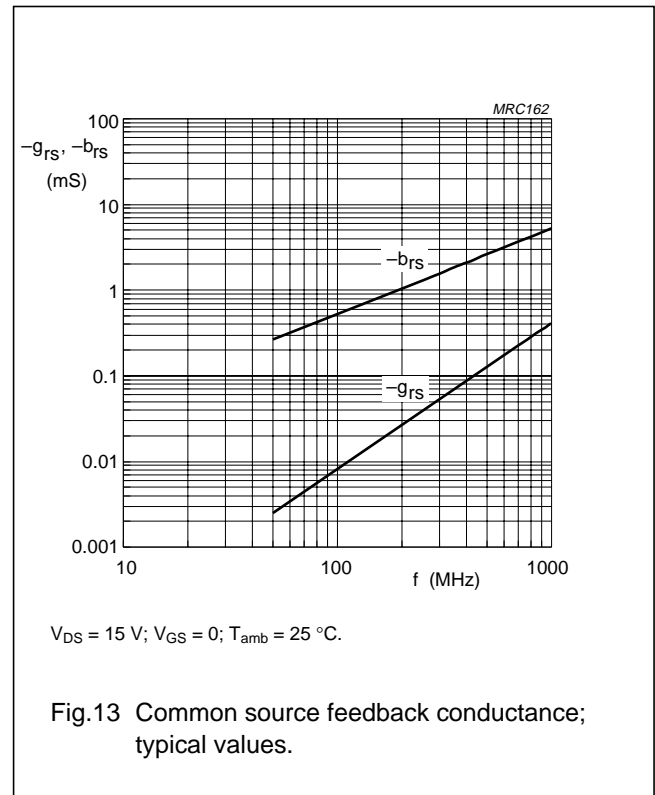
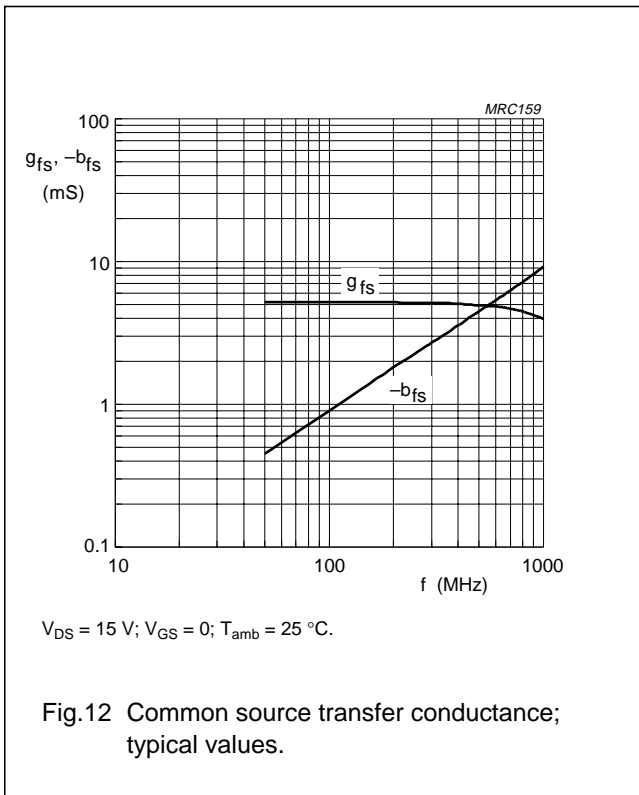

**SPICE parameters for PN4416**

September 1992; version 1.0.

1	VTO = -3.553	V
2	BETA = 792.6	$\mu\text{A}/\text{V}^2$
3	LAMBDA = 18.46	m/V
4	RD = 7.671	$\Omega$
5	RS = 7.671	$\Omega$
6	IS = 333.4	aA
7	CGSO = 2.920	pF
8	CGDO = 2.261	pF
9	PB = 1.090	V
10 (note 1)	FC = 500.0	m

**Note**

1. Parameter not extracted; default value.

N-channel field-effect transistor

PN4416; PN4416A

PACKAGE OUTLINE

Plastic single-ended leaded (through hole) package; 3 leads

SOT54

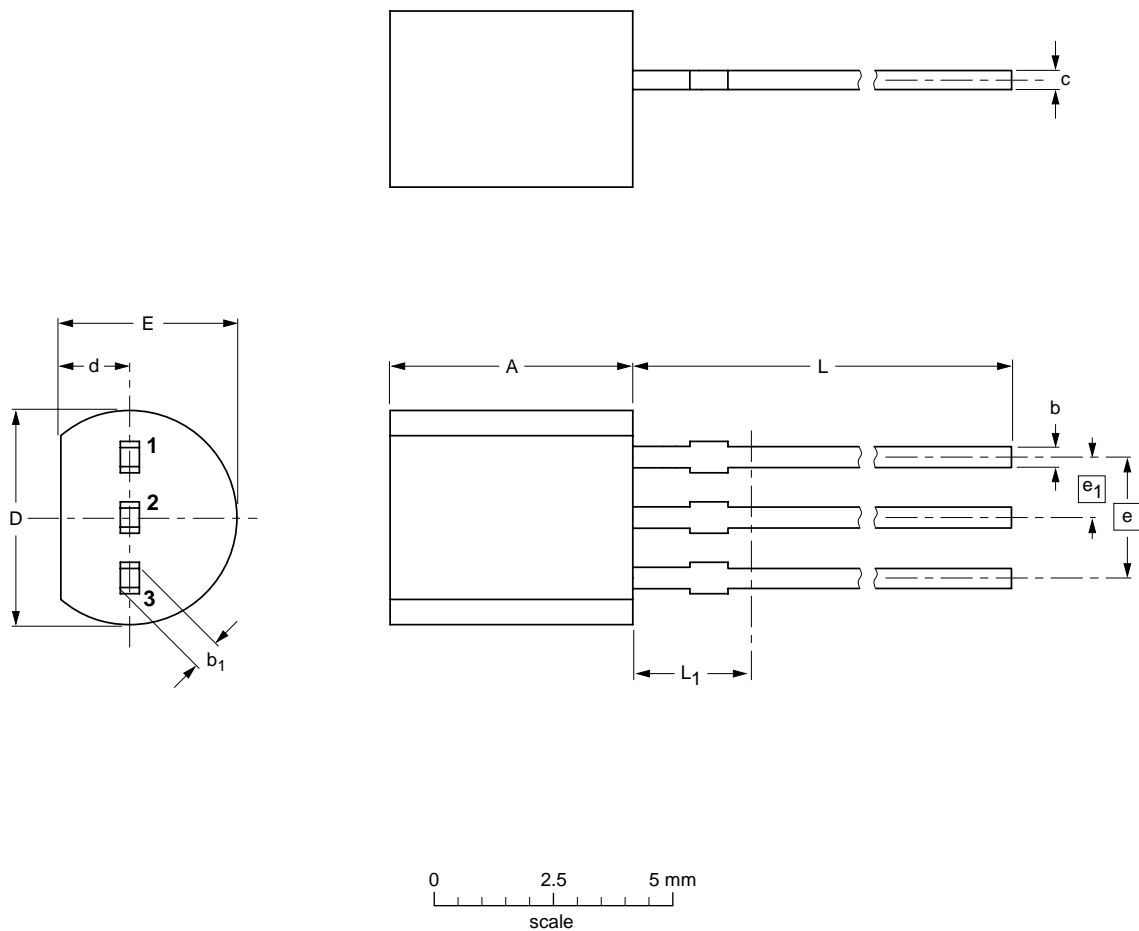

DIMENSIONS (mm are the original dimensions)

UNIT	A	b	b <sub>1</sub>	c	D	d	E	e	e <sub>1</sub>	L	L <sub>1</sub> <sup>(1)</sup>
mm	5.2 5.0	0.48 0.40	0.66 0.56	0.45 0.40	4.8 4.4	1.7 1.4	4.2 3.6	2.54	1.27	14.5 12.7	2.5

Note

1. Terminal dimensions within this zone are uncontrolled to allow for flow of plastic and terminal irregularities.

OUTLINE VERSION	REFERENCES			EUROPEAN PROJECTION	ISSUE DATE
	IEC	JEDEC	EIAJ		
SOT54		TO-92	SC-43		97-02-28



## N-channel field-effect transistor

PN4416; PN4416A

**DEFINITIONS**

<b>Data sheet status</b>	
Objective specification	This data sheet contains target or goal specifications for product development.
Preliminary specification	This data sheet contains preliminary data; supplementary data may be published later.
Product specification	This data sheet contains final product specifications.
Short-form specification	The data in this specification is extracted from a full data sheet with the same type number and title. For detailed information see the relevant data sheet or data handbook.
<b>Limiting values</b>	
Limiting values given are in accordance with the Absolute Maximum Rating System (IEC 134). Stress above one or more of the limiting values may cause permanent damage to the device. These are stress ratings only and operation of the device at these or at any other conditions above those given in the Characteristics sections of the specification is not implied. Exposure to limiting values for extended periods may affect device reliability.	
<b>Application information</b>	
Where application information is given, it is advisory and does not form part of the specification.	

**LIFE SUPPORT APPLICATIONS**

These products are not designed for use in life support appliances, devices, or systems where malfunction of these products can reasonably be expected to result in personal injury. Philips customers using or selling these products for use in such applications do so at their own risk and agree to fully indemnify Philips for any damages resulting from such improper use or sale.